

PSS 30x/32x-14

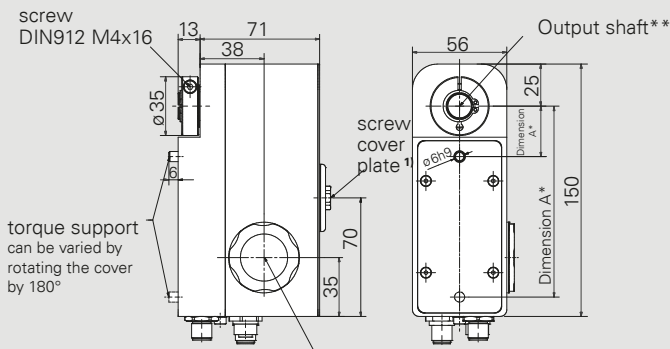

PSS 30x / 32x-14 (with hollow shaft)



viewing window and access to address switch and status display

¹⁾ over a rotating manual adjustment shaft SW6/8 depth hex

Nominal torque	Dimension A*	Output shaft**
< 10 Nm	30 ±0.1 mm	Ø14H7/20 depth
≥ 10 Nm	83.5 ±0.1 mm	Ø14H7/20 depth with feather key DIN 6885-A5x5x12

PSS 30x / 32x-14 V (with solid shaft)

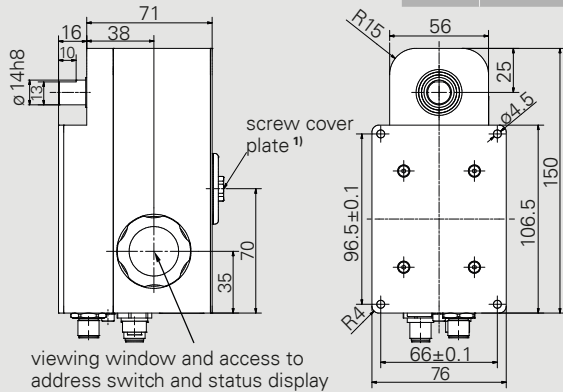

viewing window and access to address switch and status display

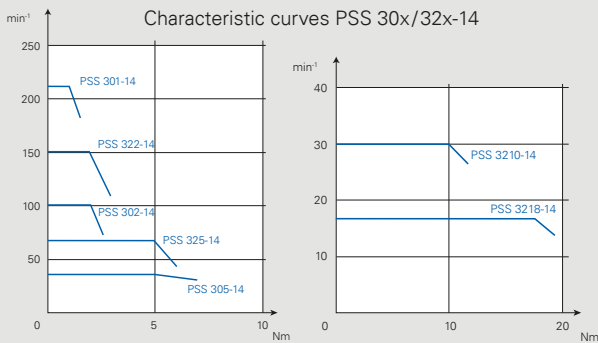

Dimensions in mm.
For details of the connections please see also the instruction manual.

Product	Nominal torque (x)	Self-holding torque (energized)	Nominal rated speed
PSS 301-14	1 Nm	0.5 Nm	210 min ⁻¹
PSS 302-14	2 Nm	1 Nm	100 min ⁻¹
PSS 305-14	5 Nm	2.5 Nm	40 min ⁻¹
PSS 322-14	2 Nm	1 Nm	150 min ⁻¹
PSS 325-14	5 Nm	2.5 Nm	68 min ⁻¹
PSS 3210-14	10 Nm	5 Nm	30 min ⁻¹
PSS 3218-14	18 Nm	9 Nm	17 min ⁻¹

Duty cycle	20% (basis time 600s) at nominal torque
Mode of operation	S3
Supply voltage	24 VDC ±10% galvanically separated between control and motor and bus
Nominal current	PSS 30x: 2.5 A, PSS 32x: 3.2 A
Power consumption (control unit)	0.1 A
Positioning accuracy absolute measurement of position taken directly at the output shaft	0.9°
Positioning range	250 rotations not subject to mechanical limits
Shock resistance in accordance with IEC/DIN EN 60068-2-27	50g 11 ms
Vibration resistance in accordance with IEC/DIN EN 60068-2-6	10..55 Hz 1.5 mm/ 55..1000 Hz 10g/ 10..2000 Hz 5g
Output shaft	14 mm solid shaft (not for PSS32x ≥10Nm) or 14 mm hollow shaft with clamp ring (for PSS32x ≥10Nm with clamp ring and feather key)
Brake	optional (holding torque=nominal torque)
Max. axial force	20 N
Max. radial force	40 N
Ambient temperature	0..45 °C
Storage temperature	-10..70 °C
Protection class	IP65 when installed and wired
Material	stainless steel housing
Weight	2000g
Certificates	CE/UKCA, optional: NRTL, optional: STO with/without test pulses ²⁾

²⁾ STO: only for EtherCAT, EtherNet/IP, POWERLINK, PROFINET, without galvanic separation of the supply voltage



How to choose your suitable positioning system?



To order our standard products, you can use the graphics on the right for an initial performance assessment of the products and the corresponding order code of the 3 series. The ordering process is described below using an example.

- A** Choose the appropriate **design** based on your operating conditions
- B** **Type:**
 - Vertical or horizontal form (value even or odd)
 - max. rated torque (x) - for orientation see characteristic diagrams
 - Output shaft (8 or 14) and solid or hollow shaft
- C** select required protocol / interface (**bus communication**)
- D** integrate the **connections** that are essential for you
- E** if necessary, select a **brake** (without brake select 0)
- F** select required **certificates**
- G** select **IP protection class**

For example, a stainless steel housing (PSS), the 30x design, a maximum rated torque of 2 Nm and an 8 hollow shaft would be required (302-8). Besides IO-Link, the standard connections are required, no brake, the CE/UKCA certificate and IP65.

→ Order code **PSS 302-8-IO-0-0-0-65**

Torques and speeds

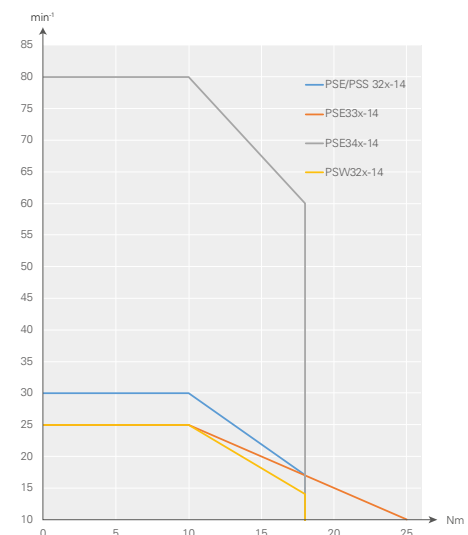
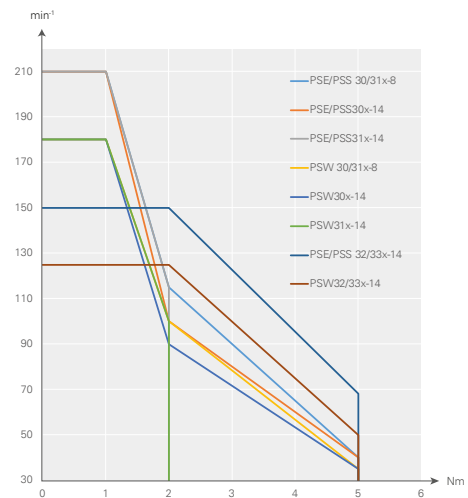



Order code PSE/PSS/PSW 3 series



	A	B	C	D	E	F	G
	Design	Type	Bus communication	Connections	Brake	Certification	IP protection class
Positioning System Efficient	PSE	30x-8 30x-8 V 30x-14 30x-14 V 31x-8 31x-8 V	CA: CANopen DP: PROFIBUS DP DN: DeviceNet ¹⁾ MB: Modbus RTU ¹⁾	0: Standard ²⁾ T: Standard with jog keys ¹⁾ X: Plug-in, L-coded ¹⁾		0: CE / UKCA N: NRTL + CE / UKCA S: STO + CE / UKCA without test pulses ¹⁾	54: IP 54 ¹⁾ 65: IP 65 ¹⁾ 68: IP 68 ¹⁾
Positioning System Stainless	PSS	31x-14 31x-14 V 32x-14 32x-14 V	SE: Sercos EC: EtherCAT PN: PROFINET EI: EtherNet/IP	Y: Plug-in, Y-coded ¹⁾ Z: Plug-in, Y-coded, with jog keys ¹⁾	0: without M: with ³⁾	T: STO + CE / UKCA with test pulses ¹⁾ Y: STO + NRTL + CE / UKCA without test pulses ¹⁾ Z: STO + NRTL + CE / UKCA with test pulses ¹⁾	
Positioning System Washable	PSW	33x-14 33x-14 V 34x-14 ⁵⁾	PL: POWERLINK IO: IO-Link				

Form/Type	Torque	Output shaft
30 horizontal	x = 1 Nm	
31 vertical	x = 2 Nm	8 = 8 mm hollow shaft
32 horizontal	x = 5 Nm	14 = 14 mm hollow shaft
33 vertical	x = 10 Nm	8V = 8 mm solid shaft ¹⁾
34 horizontal	x = 18 Nm	14V = 14 mm solid shaft ¹⁾
	x = 25 Nm ⁵⁾	

¹⁾ Not available as standard for all versions / bus communication.

Please contact our sales department.

²⁾ The standard is 3 plugs / sockets (except for IO-Link or Y-coded connector)

³⁾ only for variants with 14 mm output shafts

⁴⁾ only for PSW

⁵⁾ only for PSE

Please refer to the data sheets for the respective standard combinations.













To place your order, please call us at
+49 7661 3963-0 or email us at
info@halstrup-walcher.com.
 For additional contacts, please visit
www.halstrup-walcher.de/en/contact



Accessories for our positioning systems

The connectors shown here can be used for all 3 device types (PSE / PSS / PSW). For PSE (IP 54/IP 65) and PSS (IP 65), this ensures the IP protection classes. If required, we are happy to help you find a suitable connector for a PSW (IP 68) - please contact us.

Buscommunication	Power supply (+ databus connector) (for option 0) ¹⁾	Power supply + databus + jog key connector	Cable		
CANopen					
PROFIBUS DP				Connector set: Order no. 9601.0060	Connector set: Order no. 9601.0062
Modbus RTU					
DeviceNet			<p data-bbox="1209 954 1321 976">On request</p> 		
Sercos					
EtherCAT					
PROFINET					
EtherNet/IP					
POWERLINK					
IO-Link					
	Connector: Order no. 9601.0107				

¹⁾ see in order code under D

Screw cap to cover the second bus connection
(for PSS/PSW)

Order no. 9601.0176



Jog key box
(for Option T in section D of the Order code)

Order no. 9601.0241

Software

Use our function blocks, description files or commissioning tools for the various industrial protocols. You can download the files under www.halstrup-walcher.de/en/software. To do this, enter your specific product in the drop-down menu that appears and select the Software tab in the tab view. After that, the software components are available to you.

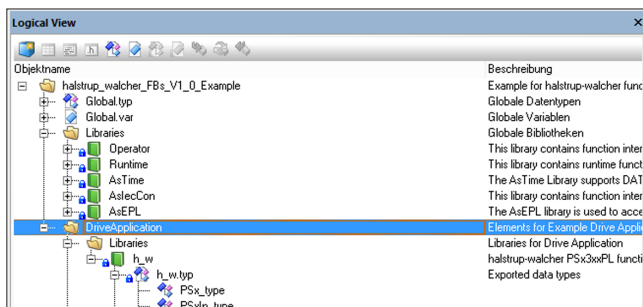

You want to see our products in person?

We are represented at numerous trade fairs and will be happy to advise you. Visit us on site and let us find the ideal solution together. You can find our current exhibition dates and product news at:



www.halstrup-walcher.de/en/news/