

Bus description

PSD4xx positioning system – EtherNet/IP

EtherNet/IP



halstrup-walcher GmbH
Stegener Straße 10
79199 Kirchzarten
Germany

Tel. +49 7661 39 63-0
info@halstrup-walcher.com
www.halstrup-walcher.com

© 2025

The manufacturer owns the copyright to this instruction manual. It contains technical data, instructions and drawings detailing the device's features and how to use them. It must not be copied either wholly or in part or made available to third parties.

The instruction manual is part of the product. Please read this manual carefully, follow our instructions, and pay special attention to the safety information provided. This instruction manual should be available at all times. Please contact the manufacturer if you do not understand any part of the instructions.

The manufacturer reserves the right to continue developing this device model without documenting such development in each individual case. The manufacturer will be happy to determine whether this manual is up-to-date.

Table of Contents

1	General	4
1.1	Explanation of symbols.....	4
2	Start-up	5
2.1	Setting the IP address	7
2.2	Switching on the device.....	7
2.3	Generate delivery state (without control unit)	8
3	EtherNet/IP description	9
3.1	Status LEDs.....	9
3.2	Characteristics of the EtherNet/IP interface.....	10
3.3	Configuration of the interface.....	11
3.3.1	Process data.....	11
3.3.2	Acyclic read and write requests.....	11
3.4	Table of the implemented parameter entries	12
3.5	Table of device dependent min., max. and default values.....	20
3.6	Process data format	23
3.6.1	Output module (from the perspective of the EIP bus master).....	23
3.6.2	Input module (from the perspective of the EIP bus master).....	23
3.7	Detailed description of status bits	24
3.8	Detailed description of control bits.....	28
3.9	PKW mechanism	29
4	Functions	32
4.1	Positioning	32
4.2	Types of positioning.....	33
4.2.1	Positioning run <i>with</i> reference loop	33
4.2.2	Positioning run <i>without</i> reference loop.....	34
4.2.3	Manual run.....	34
4.3	Velocity, acceleration and deceleration.....	35
4.4	Maximum start-up and operating torque.....	35
4.5	How to respond if the drive encounters an obstruction.....	36
4.6	How to respond if drive is turned manually (adjustment function)	36
4.7	Calculate the absolute physical position.....	38
4.8	Set the spindle pitch.....	41
4.9	Abort the run when the master fails.....	41
4.10	Reference runs	42
4.11	Run drive in reverse.....	43
5	Technical data	44
6	Notes	45

1 General

This bus description is to be used for the commissioning and integration of the drive into a field bus system.

Technical data for the electrical connections of your drive can be found in the electrical connector and pin assignment description on the website:



www.halstrup-walcher.de/technicaldocu

Please search for "PSD" and select your type, click on "Instruction manuals" and download the "connector and pin assignment" offered for your bus system.

1.1 Explanation of symbols

The device has been designed and tested to ensure its safety. However, it may still be dangerous if used inappropriately. Precautions must be taken to prevent the device being used incorrectly by mistake.

The following warnings are used in this instruction manual:

 DANGER!	DANGER! Indicates a situation of imminent danger, which will lead to a fatality or serious injuries if not prevented.
 WARNING!	WARNING! Indicates a potentially dangerous situation, which may lead to a fatality or serious injuries if not prevented.
 CAUTION!	CAUTION! Indicates a potentially dangerous situation, which may lead to minor/slight injuries if not prevented.
NOTICE	NOTICE Indicates a potentially harmful situation, which may lead to material damage if not prevented.

2 Start-up



WARNING!

Risk of injury if used inappropriately.
The device must be installed by trained technical personnel.



WARNING!

Risk of burns due to hot drive.
The drive can become very hot during operation.
Allow the drive to cool before touching it.



WARNING!

Risk of crushing due to rotary movement.
Do not reach into the working area of the drive when it is still turning.
The user/operator must ensure appropriate protective measures are taken.



WARNING!

Incorrect assembly can lead to the destruction of the drive.



WARNING!

Check that the supply lines are not pinched or crushed.
Lay the supply lines according to the general and specific local assembly regulations.
If the supply lines have not been delivered together with the device, please select suitable cables for the application.
Do not operate the direct drive if the supply lines are noticeably damaged.



WARNING!

Risk of injury. High contact voltages can occur in the case of malfunctions.
This can be prevented by grounding.



CAUTION!

The drive must be protected against excessive heating.
The user/operator must ensure appropriate protective measures are taken.



CAUTION!

Never apply force to the housing of the drive, e.g. for supporting weight.

2.1 Setting the IP address

The IP address can be set in 5 different ways:

- 1) Address assignment via DHCP:
To do this, set address 99 with the address switches before switching on.
- 2) Address assignment via BOOTP:
Before switching on, set address 98 with the address switches.
- 3) Use the last address assigned and saved:
Set address 97 with the address switches before switching on. IP address, netmask and gateway are read from the internal EEPROM and are used if they are $\neq 0$.
- 4) Specify a fixed address via the address switch:
To do this, set an address in the range of 1 .. 96 with the address switches before switching on.

This results in the following settings:
 - IP address = 192.168.1.0 + value of the address switch
 - Net mask = 255.255.255.0
 - Gateway = 0.0.0.0 (not used)
- 5) Use the last address assignment method which concurs with the current settings of TCP/IP interface object 0xF5 and persists after a reboot of the device.

Saving the address:

For variants with address switches, the currently used IP address (e.g. received via DHCP) can be permanently stored in the EEPROM of the drive by setting the address switch in the switched-on state from a value $\neq 97$ to 97.

In the delivery state, any existing address switches are set to 0. The default setting for attribute 0x03 "Configuration Control" of TCP/IP interface object 0xf5 is "0x02 → IP assignment via DHCP"

2.2 Switching on the device

After connecting the supply voltage, you may begin positioning or manual runs immediately.

You can find information about installing the drive as well as electrical connections and pin assignments under the following link: www.halstrup-walcher.de/technicaldocu

Please search for "PSD" and select your type, click on "Instruction manuals" and download the "connector and pin assignment" offered for your bus system.

2.3 Generate delivery state (without control unit)

The drive can be set to the delivery state even without the presence of a control unit.

Generate the delivery state as follows:

- 1) Separate the device from the electrical power supply.
- 2) Set the address switches to 98.
- 3) Switch the device on (control unit and motor voltage).
- 4) The yellow LED now flashes at 10 Hz for 10 seconds. If the address is set to 99 during this time, the drive will set all parameters to the delivery state, save them and run the axle to the mid-position.
- 5) Set the address switches to 00 to complete the generation of the delivery state.
- 6) Switch the device off.

The 10-second period will end immediately if a communication is established.

3 EtherNet/IP description

3.1 Status LEDs

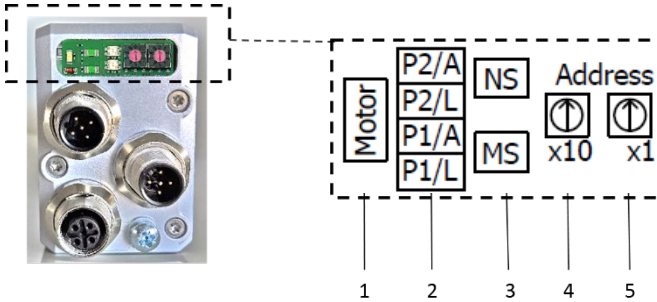

The following LEDs are located under the sealing plug:		
1	V_Motor	Yellow LED = Motor supply voltage
2	P1L/A	Green LED = Link/Activity
	P2L/A	Green LED = Link/Activity
3	MS	Red/Green LED = signals the "Module Status"
	NS	Red/Green LED = signals the "Network Status"
4	X10	Address switches x10
5	X1	Address switches x1

Meaning of the LEDs:

Yellow LED "motor supply voltage" (V_Motor)	
Off	Motor voltage too low or too high
On	Motor voltage is OK
Flashing at 0.5 Hz	Motor voltage is OK and drive is in the delivery state

Each of the ports (P1/P2) has an associated Green LED ("Link/Activity").

For each port (P1/P2) the following states are possible:	
Off	No connection
On	Line connection is active, data transfer not active
Flashing at 10 Hz	Line connection is active, data transfer active

The Red/Green dual-LED MS signals the "Module Status":	
Off	The drive is not switched on
Flashing Red/Green	Self-test (only after switching on or after a reset)
Flashing Red	Simple (correctable) error (e. g. faulty configuration)
Red on	Serious (unrecoverable) error
Flashing Green	Standby (not configured)
Green on	Ready for operation (i. e. running correctly, IP address received)

The Red/Green dual LED NS signals the "Network Status":	
Off	Not switched on or no IP address received
Flashing Red/Green	Self-test (only after switching on or after a reset)
Flashing Red	Timeout of one or more connections
Red on	The unit has detected that an IP address is already being used by another subscriber.
Flashing Green	No CIP connections have been set up and an "Exclusive Owner" connection has not been interrupted by a timeout.
Green on	At least one CIP connection has been set up

3.2 Characteristics of the EtherNet/IP interface

Both pure UCMM and connection-oriented communication with assemblies for the process data are supported (respective EDS files can be found under following link www.halstrup-walcher.de/technicaldocu).

Please search for "PSD" and select your type, click on "Software" and download the "connector and pin assignment" offered for your bus system.

To move the drive, the control word and target position must be set accordingly. These are encapsulated in the Assem100 together with the output data of the parameter interface (PLC output data).

The feedback of the drive (PLC input data, Assem101) consists of a status ("status word") and the actual values of speed and position ("actual speed", "actual position") as well as the input data of the parameter interface.

The parameters (e. g. target speed) can be set in three ways:

- 1) via the configuration when establishing the connection (Assem104)
- 2) acyclic with read/write requests
- 3) via the parameter interface in the process data (Assem100, Assem101).

The values of the parameters are stored non-volatile in the drive. This means that if individual (or all) values are not configured, the drive operates with the stored value.

In the delivery state, default values are stored that are suitable for many applications.

3.3 Configuration of the interface

Before setting the actual value of a parameter, a control bit must be transmitted that indicates whether the drive shall accept or ignore the configuration value. If the configuration value is to be ignored, this control bit must be set to 0, otherwise it will be accepted.

Example:

To adopt the target speed in the configuration, the control bit "target speed - Enable" (par. 51) must be set to 1, the value in "target speed - Value" (par. 52) is then adopted as the target speed.

The advantage of this method is that during parameterisation in the context of the unit start-up, parameters from the project planning are optionally taken over or alternatively the values stored in the EEPROM of the drive retain their validity. This is controlled via the control bit described above, which is present in the EDS file for each parameter and is displayed in the project planning.

The contents of the configuration are parameters 26 to 110. The corresponding control bits are in parameters 25 to 109.

3.3.1 Process data

A 16-byte output assembly and a 16-byte input assembly exist as process data for the EIP bus master. With the help of the process data, positioning jobs can be triggered and monitored, and parameters can also be written and read. The "PKW parameter interface" mechanism is used for this purpose.

3.3.2 Acyclic read and write requests

Instead of using the PKW parameter interface, all parameters can also be accessed via acyclic read and write requests ("Get Attribute Single" / "Write Attribute Single", class 0x64, instance 1). The parameter number for the PKW parameter interface corresponds to the attribute number for the acyclic read and write requests.

3.4 Table of the implemented parameter entries

Name	Par.-no.	Function	Range of values	Back-up?	De-livery state	R/W
Control word (can only be written in process data)	3	Bit 0: Manual run to larger values Bit 1: Manual run to smaller values Bit 2: Transfer target value Bit 3: Reserved Bit 4: Release: the axle will only run if bit is set. Bit 5: Reserved Bit 6: Run without loop Bit 7: Reserved Bit 8: Reserved Bit 9: Reserved Bit 13: Toggle bit				
Target value (can only be written in process data)	4	Target position to be achieved in 1/100 mm (for a 4 mm spindle and for default values of numerator, par. 28 and denominator, par. 30)	± 31 bit	No	0	R/W

Name	Par.-no.	Function	Range of values	Back-up?	Delivery state	R/W
Status	8	Bit 0: Target position achieved Bit 1: Reserved Bit 2: Toggle bit Bit 3: Reserved Bit 4: Power supply to motor available Bit 5: Positioning run aborted Bit 6: Drive is running Bit 7: Max temp. exceeded Bit 8: Run in opposite direction to loop Bit 9: Error Bit 10: Positioning error (obstruction) Bit 11: Manual rotation Bit 12: Incorrect target value Bit 13: Power was unavailable to motor Bit 14: Positive range limit Bit 15: Negative range limit	0... FFFFh 16 bit			R
Actual speed	9	Actual speed in rpm	±15 bit			R
Actual value	10	Current actual position in 1/100 mm (for a 4 mm spindle and for default values of numerator, par. 28 and denominator, par. 30) Writing onto this index number causes the current position to be "referenced" onto the transferred value. Writing is only possible when at a standstill.	±31 bit	No		R/W
Actual current	14	Actual current in mA	16 bit			R

Name	Par.-no.	Function	Range of values	Back-up?	Delivery state	R/W
Max. operating current during last run	15	Max. operating current during last run (start-up phase, when start-up torque applies, s. par. 66/76, and braking phase are not taken into account) Value in mA	16 bit			R
U control	16	Current supply voltage to control unit, in 0.1 V	16 bit			R
U motor	17	Current supply voltage to motor, in 0.1 V	16 bit			R
Device temperature	18	Internal device temperature in °C	16 bit			R
Address switch	19	Current position on the (optional) address switch	16 bit			R
Production date	20	Year and week of manufacturing date (given as an integer)	YYWW 16 bit			R
Serial number	21	Device serial number	0... 65.535 16 bit			R
Device model (as number)	22	Device model within the PSD series as number (e. g. 41105)	16 bit			R
Device model (as string)	23	Device model within the PSD series as string (e. g. „PSD403-14H“)	16 bit			R
Version	24	Software version number	16 bit			R
Direction of rotation	26	0: Clockwise rotation to larger values (if looking at the output shaft) 1: Anti-clockwise rotation to larger values Writing is only possible when at a standstill.	0 ... 1 16 bit	Yes	0	R/W

Name	Par.-no.	Function	Range of values	Back-up?	Delivery state	R/W
Position scaling, numerator	28	These values allow you to apply any resolution to the drive that you wish. For a numerator factor of 400, the spindle pitch / resolution is stated in the denominator factor e.g.: Spindle pitch 1.5 mm with resolution 1/100 mm: numerator = 400, denominator = 150 Writing is only possible when at a standstill.	1 ... 10000 16 bit	Yes	400	R/W
Position scaling, denominator	30	For a numerator factor of 400, the spindle pitch / resolution is stated in the denominator factor e.g.: Spindle pitch 1.5 mm with resolution 1/100 mm: numerator = 400, denominator = 150 Writing is only possible when at a standstill.	1... 10.000 16 bit	Yes	400	R/W
Referencing value	32	Correction factor for the target, actual and end limit values Writing is only possible when at a standstill.	±31 bit	Yes	0	R/W
Upper mapping end	34	Definition of the positioning range relative to the absolute value encoder Permissible values: (Actual position + 3 rotations) ... (Actual position + 4,029 rotations) Writing is only possible when at a standstill.	±31 bit	Yes	see chapt. 3.5	R/W
Upper limit	36	Maximum permitted target position Permissible values: (upper mapping end - 1,200 .. 1,611,600 * numerator/denominator) For models with an auxiliary gearbox, the range of values is reduced in accordance with the gear ratio	±31 bit	Yes	see chapt. 3.5	R/W
Lower limit	38	Minimum permissible target position Permissible values: (upper mapping end - 1,200 .. 1,611,600 * denominator/numerator) For models with an auxiliary gearbox, the range of values is reduced in accordance with the gear ratio.	±31 bit	Yes	see chapt. 3.5	R/W

Name	Par.-no.	Function	Range of values	Back-up?	Delivery state	R/W
Positioning window	40	Permissible difference between target and actual values for the "position reached" bit. The maximum setting value changes according to the same factor as the resolution. Value in increments	1 ... 100 16 bit equals 0.0025 ... 0.25 rotations	Yes	2	R/W
Length of loop	42	Minimum number of increments, in which the drive runs to a target in a specified direction. Value in increments (0: no loop) The sign determines the direction of the loop: Positive: reference loop to larger values Negative: reference loop to smaller values	0.025 ... 10 rotations or -0.025 ... -10 rotations ± 31 bit	Yes	250	R/W
Readjustment	46	Readjustment at a standstill 0: off 1: on	0 or 1 16 bit	Yes	0	R/W
Target speed	52	Maximum rpm to be used for positioning runs. Value in rpm	*) 16 bit	Yes	*)	R/W
Target speed for manual run	58	Maximum rpm to be used for manual runs. Value in rpm	*) 16 bit	Yes	*)	R/W
Speed limit for aborting run	60	Value in % of the target speed	30 ... 90 16 bit	Yes	30	R/W
Acceleration	62	Value in rpm per second	*) 16 bit	Yes	*)	R/W
Deceleration	64	Value in rpm per second	*) 16 bit	Yes	*)	R/W
Maximum start-up torque	66	Value in cNm	*) 16 bit	Yes	*)	R/W

Name	Par.-no.	Function	Range of values	Back-up?	Delivery state	R/W
Maximum operating torque	68	Applies after the end of the start-up phase (during the start-up phase, the value from par. 66 applies). Value in cNm	*) 16 bit	Yes	*)	R/W
Max. holding torque at end of run	70	Value in cNm	*) 16 bit	Yes	*)	R/W
Maximum holding torque	72	Holding torque at a standstill in cNm (after the phase "max. holding torque at end of run")	*) 16 bit	Yes	*)	R/W
Time elapsed until speed falls below speed limit for aborting run	74	Value in ms (see also par. 60)	50 ... 500 16 bit	Yes	200	R/W
Time period for start-up torque	76	Time period during which the max. start-up torque is applied during the start of a movement. Value in ms, see also par. 66)	10 ... 1000 16 bit	Yes	200	R/W
Duration of max. holding torque at end of run	78	Time period during which the holding torque is applied at completion of run. Value in ms, see also par. 70	0 ... 1000 16 bit	Yes	200	R/W
UMot filter	86	Average time for motor voltage measurement; in ms.	100 ... 1000 16 bit	Yes	100	R/W
General purpose register	88 - 106	10 general purpose registers	32 bit	Yes	0	R/W
UMot limit	108	Voltage limit for Bit 4 ("Power supply to motor available"); in 0.1 V A positioning run or manual run can only be started if the motor voltage is higher than the value set here. During the run, the voltage may fall to 17.5 V.	180 ... 240 16 bit	Yes	185	R/W

Name	Par.-no.	Function	Range of values	Back-up?	De-livery state	R/W
Temperature limit	110	Upper temperature limit in °C	10 ... 80 16 bit	Yes	80	R/W
Delivery state	113	<p>Writing a "-6": Resets the drive (corresponds to switching the control voltage off and back on)</p> <p>Writing a "-5": Sets the values of all parameters to the delivery state, saves the parameters in EEPROM, then positions the drive in the middle of the measurement range *) (IP address, netmask, gateway and IP address assigning method stay unaffected)</p> <p>Writing a "-4": Sets the values of all parameters to the last values saved by the user, then positions the drive in the middle of the measurement range. *) (IP address, netmask, gateway and IP address assigning method stay unaffected)</p> <p>Writing a "-3": Sets the values of all parameters to the delivery state, deletes IP address, netmask, gateway and IP address assigning method and saves parameters in EEPROM</p> <p>Writing a "-2": Sets the values of all parameters to the last values saved by the user without saving the parameters in EEPROM (IP address, netmask, gateway and IP address assigning method stay unaffected)</p> <p><i>Continues on next page</i></p>	-6 ... -1 or 1 (when writing) ±15 bit	No		R/W

Name	Par.-no.	Function	Range of values	Back-up?	De-livery state	R/W
Delivery state	113	<i>Continuation</i> Writing a "-1": Sets the values of all parameters to the delivery state without saving the parameters in EEPROM (IP address, netmask, gateway and IP address assigning method stay unaffected) Writing a "1": Saves the parameters in EEPROM. Writing is only possible when at a standstill.	-6 ... -1 or 1 (when writing) ±15 bit	No		R/W

*) In cyclical data exchange, the control word is ignored during positioning in the middle of the measurement range (unless this changes). This allows the positioning run to the middle of the measurement range to be aborted by changing control word. Run commands issued before ordering the positioning run to the middle of the measurement range will not be restarted automatically after this has been performed. (i.e. the control word 0x14 and old target value do not lead to this position being reached.)

3.5 Table of device dependent min., max. and default values

NOTICE

The operating current setting is optimised for the nominal rated speed of the respective device model. The more the set speed deviates from the nominal rated speed (rpm), the more the actual power consumption of the motor circuit deviates from the set value.

NOTICE

Setting the value for the holding current to 0 results in a max. power consumption by the motor circuit of approx. 50 mA.

Device model		PSD 401/411 - 5V	PSD 401/411 - 8H/14H	PSD 403/413 - 8H/14H	PSD 422/432 - 8V	PSD 422/432 - 8H/14H
Name	Par.- no.	Range of values Delivery state				
Upper mapping end*)	34	806,400	806,400	198,498	806,400	806,400
Upper limit*)	36	805,200	805,200	197,298	805,200	805,200
Lower limit*)	38	-805,200	-805,200	-197,299	-805,200	-805,200
Target speed for positioning run	52	1 ... 800 200	1 ... 500 200	1 ... 250 50	1 ... 1000 200	1 ... 500 200
Target speed for manual run	58	1 ... 800 70	1 ... 500 70	1 ... 250 17	1 ... 1000 70	1 ... 500 70
Acceleration	62	1 ... 5000 1000	1 ... 5000 1000	1 ... 1250 250	1 ... 5000 500	1 ... 5000 500
Deceleration	64	1 ... 5000 2000	1 ... 5000 2000	1 ... 1250 500	1 ... 5000 2000	1 ... 5000 2000
Max. start-up torque	66	30 ... 90 50	30 ... 90 50	115... 350 190	50 ... 240 120	50 ... 240 120
Max. operating torque	68	30 ... 80 40	30 ... 80 40	115... 300 150	50 ... 240 100	50 ... 240 100

Max. holding torque at end of run	70	0 ... 80 30	0 ... 80 30	0 ... 325 120	0 ... 200 70	0 ... 200 70
Max. holding torque	72	0 ... 60 20	0 ... 60 20	0 ... 245 80	0 ... 150 50	0 ... 150 50

Device type		PSD 424/434 - 14H	PSD 426/436 - 14H	PSD 428/438 - 14H	PSD 480/490 - 5V	PSD 480/490 - 8H/14H	PSD 481/491 - 8H/14H
Name	Par.- no.	Range of values Delivery state					
Upper mapping end*)	34	388,800	256,000	196,683	806.400	806.400	198.498
Upper limit*)	36	387,600	254,800	195,483	805.200	805.200	197.298
Lower limit*)	38	-387,600	-254,800	-195,483	-805.200	-805.200	-197.298
Target speed for positioning run	52	1...482 100	1...317 63	1...250 50	1...800 200	1...500 200	1...250 50
Target speed for manual run	58	1...482 34	1...317 22	1...250 17	1...800 70	1...500 70	1...250 17
Acceleration	62	1...2411 240	1...1587 150	1...1250 125	1...5000 1000	1...5000 1000	1...1250 250
Deceleration	64	1...2411 960	1...1587 635	1...1250 500	1...5000 2000	1...5000 2000	1...1250 500
Maximum start-up torque	66	100...480 240	150...720 360	195...935 465	9...30 15	9...30 15	26...120 60
Maximum torque	68	100...480 200	150...720 300	200...935 400	9...30 13	9...30 13	36...120 50
Maximum holding torque at end of run	70	0...400 140	0...630 220	0...820 285	0...25 9	0...25 9	0...100 35
Maximum holding torque	72	0...300 100	0...470 155	0...615 205	0...19 7	0...19 7	0...75 25

*) The min. and max. values for the parameters cannot be stated because they are dependent on the current scaling. The value applies for the standard scaling (400 increments per rotation).

3.6 Process data format

3.6.1 Output module (from the perspective of the EIP bus master)

Bit	Byte	Meaning	Corresponding parameter index
0-15	0-1	Status	8
16-31	2-3	Current rpm	9
32-63	4-7	Actual position	10
64-79	8-9	PKE	11
80-95	10-11	IND	12
96-127	12-15	PWE	13

NOTICE

Assignment (cannot be modified)

3.6.2 Input module (from the perspective of the EIP bus master)

Bit	Byte	Meaning	Corresponding parameter index
0-15	0-1	Control Word	3
16-31	2-3	Reserved	-
32-63	4-7	Target value	4
64-79	8-9	PKE	5
80-95	10-11	IND	6
96-127	12-15	PWE	7

NOTICE

Assignment (cannot be modified)

In case the parameter interface (PKE/IND/PWE) is not required, with the help of the EDS file the data length might be reduced from 16 byte to 8 byte both for the output and the input assembly. For this purpose, set Param1 and Param2 to the entry "without Parameter Interface".

NOTICE

Param1 and Param2 always must hold the same entry (e. g. both "with Parameter Interface" or both "without Parameter Interface").

3.7 Detailed description of status bits

Bit 0 Target position reached

This bit is set:

- when a transferred target position has been reached successfully (not at the end of a manual run unless the target position is also the relevant end limit)
- after manual displacement while at standstill, if readjustment is activated and the absolute value of the difference of actual and target value is smaller or equal to the positioning window again.

If bit 0 is to be set at the same time as bit 10 (obstruction), bit 0 has priority!

This bit is reset:

- after transferring a target position when the difference from the actual value is larger than the positioning window (par. 40)
- by a manual run
- if an invalid target value has been transferred
- as a result of manual rotation when not in operation

Bit 1 Reserved

Bit 2 Toggle bit

This bit is set:

- when bit 13 of the control word is set

This bit is reset:

- when bit 13 of the control word is reset

Bit 3 Reserved

Bit 4 Power supply to motor available

This bit is set:

- if the supply voltage for the motor is above the U_{Mot} limit (par. 108) and below 30 V

This bit is reset:

- if the supply voltage for the motor is below the U_{Mot} limit or above 30 V

Bit 5 Positioning run aborted

This bit is set:

- if a positioning run is aborted because the release has been withdrawn in the control word or due to an invalid bit combination in the control word

This bit is reset:

- for every new run command

Bit 6 Drive is running

This bit is set:

- when the drive is rotating

This bit is reset:

- when the drive is at a standstill

Bit 7 Temperature too high

This bit is set:

- when the internal device temperature rises above the limit value from par. 110

This bit is reset:

- when the internal device temperature falls below the limit value by 5 °C

Bit 8 Run in opposite direction to loop

This bit is set:

- when switching on or after a reset (any lash present has not yet been eliminated)
- when initiating a positioning or manual run against the direction of the loop

This bit is reset:

- when length of loop par. 42 = 0 and a positioning or manual run is initiated
- when a transferred target position in the direction of the reference loop has been reached successfully (not after a manual run)

Bit 9 Error bit

This bit is set:

- when an internal problem is detected when calculating the position

No more run commands may be transmitted when the error bit is set!

This bit is reset:

- only possible by resetting the drive

Bit 10 Positioning error (obstruction)

This bit is set:

- if a positioning or manual run is aborted because the device is overloaded (obstructions, extreme difficulty running)

If bit 0 (Target position achieved) should be set at the same time as bit 10 (obstruction), bit 0 has priority!

This bit is reset:

- for every new run command

Bit 11 Manual rotation

This bit is set:

- when the drive is rotated externally at a standstill by more than the value in the positioning window after a positioning run has been completed correctly beforehand

This bit is reset:

- for every new run command

Bit 12 Incorrect target value

This bit is set:

- if a transferred target value lies outside the range of the end limits, caused e.g. by the current reference value (par. 32)
- if a transferred target value lies within the range of the end limits, but would leave the specified range during the required reference loop

This bit is reset:

- for every new run command

Bit 13 Motor voltage was missing

This bit is set:

- if the motor voltage is below the UMot limit when initiating a positioning or manual run (par. 108) and above 30 V
- if the motor voltage leaves the specified range during the run

This bit is reset:

- if the motor voltage is greater than the UMot limit and under 30 V when initiating a positioning run or manual run

Bit 14/ **Forward/reverse limit reached**

Bit 15

This bit is set:

- if the limit value is reached during a manual run
(not when reached during a positioning run)
- if an end limit is modified such that the current position lies beyond it
- if, when at a standstill, the drive is moved to a position beyond the range defined by the end limit by an external force

This bit is reset:

- as soon as the drive is once again within the range defined by the end limits (exception: after a manual run, the drive is still at the end limit within the positioning window and no new run command has yet been given.)

3.8 Detailed description of control bits

Bit 0 Manual run to larger values

Bit 1 Manual run to smaller values

Bit 2 Transfer target value

If this bit is set, the target value in the process data will be accepted as the new valid target value. A positioning run starting at the same time or later will use this target value as the new target position. If the positioning run is supposed to start at the same time as the transfer of the target value, control bit 4 ("release") must also be set.

If bit 2 is not set, the target value will not be accepted. Instead, a positioning run will be started to the last transmitted target value that has been marked as valid.

Bit 3 Reserved

must be set to 0

Bit 4 Release

Run commands will only be executed if this bit is set. This bit must be set for positioning runs and manual runs. If this bit is reset during a run, the run will be aborted and status bit 5 ("positioning run aborted") will be set.

Bit 5 Reserved

must be set to 0

Bit 6 Run without a reference loop

If this bit is set, all target positions will be approached directly during positioning runs (independently of the current value of par. 42), without a reference loop.

Bit 7-12 Reserved

must be set to 0

Bit 13: Toggle bit

The drive always writes this bit in status word bit 2.

→ The control unit can recognise when new process data from the drive are processed.

Bit 14-15: Reserved

must be set to 0

3.9 PKW mechanism

The PKW mechanism (PKW = “parameter identification value”) can be used to read and write parameter values in cyclical data transfer activity as well as recalling other values from the drive.

In the PKW mechanism, the IO controller issues and transfers a command. It repeats this command cyclically until the drive has processed the command and sent a response.

The drive keeps the response available until the IO controller has formulated a new command. A parameter value sent back by the drive as a response to a read access, relates to the point in time at which the command was issued, i. e. if the progress of a parameter value is to be observed over a longer period of time, the IO controller must send a new command after accepting the current parameter value. This is done by setting the command code 0 (“no command”) and then waiting until the drive confirms this with the response code 0 (“no response”). The same parameter value can then be required once again.

Only one command can be processed per drive at any time.

PKW format:

PKW							
PKE		IND		PWE			
0	1	2	3	4	5	6	7

PKE	Parameter ID
IND	Index
PWE	Parameter value

Parameter code (PKE) format:

The “parameter code” (PKE) information consists of a data byte (bytes 0 and 1 of the PKW section), which contains the codes for the type of command (and/or response) and the associated parameter numbers:

Parameter code PKE															
Bit. no.															
15	14	13	12	11	10	9	8	7	6	5	4	3	2	1	0
AK				SPM		Parameter number (PNU)									

AK	Command and/or response code
SPM	Toggle bit for spontaneous message (function not implemented)
PNU	Parameter number

The parameter number PNU is derived from the table above (“Table of implemented parameter entries”).

Command code (IO controller → drive):

Com- mand code	Function	Possible response code of the drive *)	
		positive	negative
0	No command	0	7
1	Require parameter value	1 or 2	
2	Change parameter value (word)	1	
3	Change parameter value (double word)	2	
6	Require parameter value (array)	4 or 5	
7	Change parameter value (array word)	4	
8	Change parameter value (array double word)	5	
9	Require number of array elements	6	

*) The column "response code" contains the possible responses to a command in the cases of the command being completed successfully ("positive") or unsuccessfully ("negative").

Response code (drive → IO controller):

Response code	Function
0	No response
1	Transfer parameter value (word)
2	Transfer parameter value (double word)
4	Transfer parameter value (array word)
5	Transfer parameter value (array double word)
6	Transfer number of array elements
7	Command cannot be executed

Subindex IND:

The field IND contains the array subindex for commands and responses relating to array elements.

Parameter value PWE:

This field contains the numeric value for the respective parameter.

For orders that cannot be executed (i. e. response code AK = 7), the drive responds with the appropriate error code (see the table below):

Error code	Meaning
0	Parameter number not permitted
1	Parameter value cannot be changed
2	Lower or upper limit value exceeded
3	Error in the subindex
4	No array
5	Incorrect data type
6	Setting not permitted (only resetting)
17	Order cannot be executed due to operating status
18	Other error

If the write command of parameter values has been processed correctly (i. e. command code AK = 2, 3, 7 or 8) this response contains the same data as reading this parameter value. Depending on the data type, the response code AK is then one of the values 1, 2, 4 or 5. The parameter number (PNU), the index (IND) and parameter value (PWE) are stated as in the command. This makes it possible to check that the drive has actually accepted the requested values.

4 Functions

4.1 Positioning

In order to control the drive, this must first be transferred into the cyclical data exchange.

- Transfer target value:
Control word = 0x14 and desired target value
→ drive begins to run
- Aborting a run by withdrawing release:
Control word = 0x00

If a new target value is transferred during a positioning run, the device will immediately proceed to the new target. This will occur with no interruption provided the direction of rotation does not need to be altered.

If a manual run command is transmitted during a positioning run, the positioning run will be aborted (velocity will be reduced to that of a slow run) and the operator may proceed with the manual run.

The following sequence of steps is also possible:

Starting conditions: release has not been set.

- Transfer target value:
Control word = 0x04 and desired target value
- Set release:
Control word = 0x10
→ Drive begins to run

NOTICE

Positioning runs may include a "reference loop" which ensures the target is approached from a defined direction. The direction and length of the reference loop can be set to the required value before positioning using par. 42 ("length of loop"). Par. 42 can also be used to deactivate the reference loop.

4.2 Types of positioning

4.2.1 Positioning run *with* reference loop

The PSD4xx distinguishes between the following steps of a positioning sequence (Assumption: the target position is always approached through forward motion)

- 1) New position value is larger than the current value:
position approached directly.

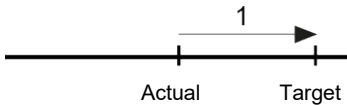

- 2) New position value is smaller than the current value:
the drive reverses an additional 5/8 of one rotation (2a)
and approaches the exact position after resuming forward motion (2b).

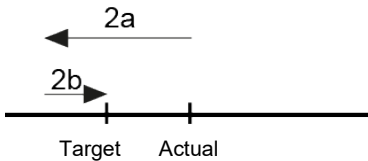

- 3) New position value after reverse run (no reference loop):
the drive always approaches by moving forward (3b),
if necessary, it will first reverse by 5/8 of a rotation (3a).

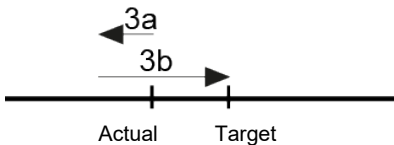

After reaching the target position, this position is compared with the internal absolute encoder position. In case of a deviation, the status bit "Error" is set.

NOTICE

It is not possible to perform a positioning run to the upper limit (par. 36) with a length of loop > 0 because the drive would have to run past the upper limit in order to do so. The same applies to the lower limit (par. 38) with length of loop < 0 .

4.2.2 Positioning run *without* reference loop

The “positioning without a reference loop” mode is used primarily for moving the small distances involved in fine adjustments. In this case, each position is approached directly.

NOTICE

This does NOT eliminate any lash present in the driven spindle.



CAUTION!

Runs, which intentionally involve a run to an obstruction (e.g. reference runs to a block), may only be started with reduced torque (running torque to minimum value).

4.2.3 Manual run

The drive can be operated manually (so-called “Manual run”). This helps to simplify start-up.

Start manual run:

- Transfer control word
Control word = 0x11 and/or 0x12
→ Starts the manual run

End manual run:

- Transfer control word or reset release bit
Control word = 0x10 and/or 0x00
→ Stops the manual run

NOTICE

If a positioning run is required during an active manual run, the drive must be stopped (reset the release bit). The positioning run can be initiated as soon as the drive is stationary (control word = 0x14 and the desired target value).

4.3 Velocity, acceleration and deceleration

Manual runs are performed with the max. velocity stated in par. 58, positioning runs with the max. velocity stated in par. 52.

For all runs, the maximum acceleration from par. 62 and the maximum deceleration from par. 64 apply.

As the drive approaches the target at the end of the run, the deceleration is successively reduced in order to ensure a harmonious transient response.

If a stop command is executed, the drive brakes with the maximum possible deceleration ramp independently of the value in par. 64.

4.4 Maximum start-up and operating torque

The maximum start-up torque can be set using par. 66, the maximum operating torque using par. 68.

The start-up torque is active after each run begins for the period defined in par. 76.

NOTICE

The stepper motor is optimized for maximum torque. If the PSD is operated at speeds above 400 rpm, self-resonance or even self-locking occurs. Just by adding an inert mass, the natural resonance is significantly damped!

NOTICE

The start-up torque should always be slightly higher than the operating torque because the drive requires more power during the acceleration phase than when running at a constant velocity.

NOTICE

If small torque limits are to be used, the following must be considered: Small operating torque value should not be used in combination with high speed settings as this can lead to instability!

4.5 How to respond if the drive encounters an obstruction

If an obstruction is detected, the run is aborted and the "Positioning error" bit is set. The PSD4xx now operates with the specified max. holding torque (par. 72).

After this, new run commands can be sent without taking further measures, i.e. transferring a new target position (changing the value of the target position in the process data) starts a new positioning run.

Exception:

The exception to this is if the target value is the same as before. In this case, cancel the release and reset it (bit 4 in the control word). Bit 2 ("Transfer target value") must be set in this case. The drive then begins a new positioning run.



CAUTION!

Runs which intentionally involve a run to an obstruction (e. g. reference runs to a block) may only be started with a reduced torque (max. operating torque < 10 % of nominal rated torque or smallest possible value).

4.6 How to respond if drive is turned manually (adjustment function)

If the PSD4xx is rotated in the opposite direction from the reference loop – when at a standstill, after a correctly completed positioning run and the release bit (bit 4 in the control word) as well as the readjustment bit (par. 46) are activated – it will again attempt to run to the previously sent target value (adjustment). After successful readjustment bit 0 will be set again.

The device does not attempt to adjust if rotated in the direction of the reference loop, it will merely set bit 11 of the status word ("Manual rotation") and reset bit 0 ("Target position reached"). If the reference loop is deactivated (par. 42 = 0), the drive will adjust in both directions.

NOTICE

The device does not attempt to adjust if rotated in the direction of the reference loop, it will merely set bit 11 of the status word ("Manual rotation") and reset bit 0 ("Target position reached").

NOTICE

If the drive continually loses its position when at a standstill, it will attempt to adjust whenever its actual position just leaves the positioning window (provided that all of the above-mentioned conditions are met). At this time, the motor voltage must be within the permissible range (i.e. bit 4 is set in the status word).

No adjustment will start if the motor voltage is not in the permissible range. Instead, bits 10

("Positioning error") and 13 ("Power was unavailable to motor") will be activated.

If the motor voltage only returns to the permissible range after leaving the positioning window, no new adjustment attempt will start. This prevents a situation in which the drive suddenly starts to move when the motor voltage is switched on.

If a positioning run or manual run is aborted while in progress by a stop command ("Release" bit in control word to 0), the drive will only adjust when a new run command is sent and completed correctly.

Deleting the release bit and/or adjustment function can completely prevent the adjustment process.

4.7 Calculate the absolute physical position

The PSD4xx actuator includes an absolute measuring system capable of covering a range of 4,026 rotations. This allows the user to determine the direction of rotation for any desired portion of these 4,026 rotations.

The mapping of the desired positioning range to the physical positioning range “mapping end” is performed via par. 34.

In the delivery state, the drive is positioned at 0, the upper limit is positioned at 805,200, the lower limit positioned at -805,200. This results in a positioning range of $\pm 2,013$ rotations ($\pm 805,200$ increments). If the desired positioning range does not exceed $\pm 2,013$ rotations, none of the steps described below are required to set the positioning range in the delivery state.

The following two options are available to allow you to realise any desired positioning run distances independently of the run distance set by the mounting orientation of the measurement system (physical positioning range):

- 1) Bring the axle to be moved (e. g. a spindle) into the desired position, run the drive to the appropriate position with the adjustable collar open and only then close the adjustable collar.

Examples:

- a) Bring the axle to be positioned into the mid-position, run the drive in neutral (with the adjustable collar open) to the mid-position (position 0), then close the adjustable collar. The drive can now run 2,013 rotations in both directions (default $\pm 805,200$ increments).
 - b) Bring the axle to be positioned all the way to the left (or bottom), run the drive in neutral (with the adjustable collar open) without a loop to the smallest position (position - 805,200), then close the adjustable collar. The drive can now run 4,026 rotations to the right (or top) (default 1,610,400 increments).
 - c) Bring the axle to be positioned all the way to the right (or top), run the drive in neutral (with the adjustable collar open) to the largest position (position 805,200), then close the adjustable collar. The drive can now run 4,026 rotations to the left (or bottom) (default 1,610,400 increments).
- 2) Mount the drive in the required position on the axle, close the adjustable collar, then adjust the positioning range using par. 34. Parameter 34 sets the upper end of the positioning range. Default setting: upper end at +2,016 rotations (position 806,400). If, after mounting the drive, the positioning range does not match the currently displayed position, you can select the positioning range between +3 ... +4,029 rotations.

Examples:

- a) After mounting the drive, the position 0 is displayed (which corresponds to the delivery state). The positioning range should point exclusively to the right (or top)
 - Upper mapping end = position +4,029 rotations
 - Set par. 34 to 1,611,600
- b) After assembly, the displayed position is 804,000. However, the positioning range should point exclusively to the right (or top)
 - Upper mapping end = position +4,029 rotations
 - Set par. 34 to 2,415,600
- c) After assembly, the displayed position is -804,000. However, the positioning range should point exclusively to the left (or down)
 - Upper mapping end = Position +3 rotations
 - Set par. 34 to -803,200

Notes:

- 1) When calculating the upper mapping end (par. 34) (as in the above examples), it is essential to include a safety margin of 3 rotations (by default 1,200 increments), because the highest possible position value is 3 rotations below the upper mapping end. The smallest possible position value is 4,029 rotations below the upper mapping end.
- 2) The numbers of increments or position values indicated relate to the following settings, which correspond to the delivery state:
 - a) Reference value (par. 32) = 0
 - b) Position scaling, numerator (par. 28) = 400
 - c) Position scaling, denominator (par. 30) = 400

These 3 parameters affect the above numbers of increments or position values: The reference value can be used to shift the range of values, the numerator/denominator to stretch or extend the range of values (see below).

- 3) If the direction of rotation is changed (par. 26), the reference value (par. 32), the upper mapping end (par. 34) and the upper and lower limits (par. 36 and 38) will be set to the delivery state.
- 4) When the upper mapping end is changed (par. 34), the upper and lower limits (par. 38) will be set to the delivery state.
- 5) If the positioning scaling is changed (numerator; par. 28 or denominator; par. 30), the target value, actual value, reference value, upper mapping end and the upper and lower limits, positioning window and length of loop will be recalculated.
- 6) If the reference value is changed (par. 32), the target value, actual value, upper mapping end and the upper and lower limits will be recalculated.

- 7) If the user wants to avoid any automatic adjustment of values when setting the parameters for the drive, the optimum order for sending the parameters is as follows:
 - a) Direction of rotation (par. 26)
Position scaling, numerator (par. 28)
Position scaling, denominator (par. 30)
 - b) Reference value (par. 32)
 - c) Upper mapping end (par. 34)
 - d) Upper limit switch (par. 36)
Lower limit switch (par. 38)
Positioning window (par. 40)
Length of loop (par. 42)
- 8) To save the settings permanently in EEPROM write a 1 in par. 113.
Saving can take up to 1 second.

Reference value (par. 32):

The referencing process affects all transferred values, i. e., the target value, actual value, upper mapping end and upper and lower limits.

There are two ways of setting the referencing value:

- 1) Directly – by writing the referencing value in par. 32.
- 2) Indirectly – by writing an actual value to par. 10. This makes it possible to assign any “true” actual value to the current, physical actual value. The resulting difference is then the referencing value. This value will immediately be included in calculations for each transferred value and can also be read under par. 32.

If the reference value is changed, the target value, actual value, upper mapping end and the upper and lower limits will be automatically recalculated.

NOTICE

Removal of the supply voltage to the **motor** has no effect on the internal measurement system.

4.8 Set the spindle pitch

Using par. 28 (numerator factor) and par. 30 (denominator factor), it is possible to represent any desired spindle pitch using the position scaling factors:

$$\text{Number of increments per rotation} = 400 \times \frac{\text{Denominator factor}}{\text{Numerator factor}}$$

Both factors are set to a value of 400 by default, resulting in a resolution of 0.01 mm at a spindle pitch of 4 mm.

The denominator factor serves as a simple means of setting the spindle pitch and resolution. The numerator factor is primarily used for setting “unlevel” resolutions.

Examples:

Spindle pitch	Resolution	Numerator factor	Denominator factor
4 mm	1/100 mm	400	400
1 mm	1/100 mm	400	100
2 mm	1/10 mm	400	20

NOTICE
Numerator and denominator factors may take on values between 1 and 10,000.

4.9 Abort the run when the master fails

If the connection to the master is interrupted during a positioning run, the master cannot abort a run that is already underway. The drive monitors communication with the IO controller so that an automatic run abort can be generated in such a case. A run abort is triggered in the case of a timeout. If, during the restoration of the connection, the process data contain valid values, the drive will immediately continue the run.

4.10 Reference runs

The PSD4xx positioning system is equipped with an absolute measuring system, so no reference run is required when the drive is switched on. If a reference run should be required to a hard obstruction in a specific instance (e.g. once during installation of the drive on a machine), the procedure should be as follows:

- 1) Prior to ordering the reference run, adjust the settings as follows:
 - a) Set max. operating torque (par. 68) and max. start-up torque (par. 66) to 10 % of the max. value, resp. the lowest possible values.
 - b) Set max. holding torque (par. 72) and max. holding torque at end of run (par. 70) to 0.
 - c) Set speed limit for aborting run (par. 60) to 60.
 - d) Set the time elapsed until speed falls below speed limit for aborting run (par. 74) to 100. (The time during which the drive tries to overcome the obstruction decreases: with these reduced values, the positioning run is aborted if the speed (rpm) remains below 60 % of the target speed for longer than 100 ms. The default settings are 200 ms and 30 %.)
 - e) Set the affected end limit (par. 38 or par. 36) so that the obstruction is clearly within the end limits in each case. (Otherwise there is a risk that the obstruction will lie within the positioning window and therefore not be recognised.)
 - f) If necessary, reduce the target speed for manual operation (par. 58)
- 2) Now start the reference run as a manual run (bit 0 or 1 in the control word).
- 3) Wait until the drive is running (bit 6 is set in the status word)
- 4) Wait until the drive is stationary and a positioning error has occurred (bit 6 of the status word is reset, bit 10 is set).
- 5) Using the same settings, perform a manual run in the opposite direction (move a little distance away from the obstruction so the drive can move freely).
- 6) Only now use desired settings for normal operation of the above parameters.

4.11 Run drive in reverse

Depending on the model, the drive may be run in reverse up to a certain speed.



CAUTION!

Running a PSD4xx in reverse for more than 1-2 seconds at more than the permissible speed will damage the internal protection diode and the PSD4xx will be defective.

Please refer to the following table to find the maximum permissible speed:

Device model	PSD 401/411 - 5V/8H/14H	PSD 403/413 - 8H/14H	PSD 422/432 - 8V/8H/14H	PSD 424/434 - 14H	PSD 426/436 - 14H
Max. permissible speed [rpm]	200	48	200	95	60

Device model	PSD 428/438 - 14H	PSD 480/490 - 5V	PSD 480/490 - 8H/14H	PSD 481/491 - 8H/14H
Max. permissible speed [rpm]	45	200	200	48

5 Technical data

Technical data and drawings can be found in the current data sheet on the website:
www.halstrup-walcher.de/technicaldocu

Please search for "PSD" and select your type, click on "Data sheets".

Please contact us if you require any further information.

6 Notes

